



# Legende / legend / légende

## Besatzhärte / bristles stiffness / dureté du fibre

	weich / soft / doux
	mittel / medium / moyen
	hart / hard / dur











## Faserende / bristles / fibre

I	ungeschlitztes Faserende / not flagged bristles / fibre non-fleuré
∇	geschlitztes Faserende / flagged bristles / fibre fleuré
▲	gespitztes Faserende / pointed bristles / fibre pointu



## Material / material / matériel

ABS	ABS
HM	Haarmischung / hair-mixture / mixture de poil
Nyl 6.0	Nylon 6.0 / nylon 6.0 / nylon 6.0
Nyl 6.6	Nylon 6.6 / nylon 6.6 / nylon 6.6
PA	Polyamid / polyamide / polyamide
PA GF	Polyamid Glasfaser / polyamide fiberglass / polyamide fibre de verre
PBT	Polyester PBT / polyester PBT / polyester PBT
PE	Polyäthylen / polyethylene / polyéthylène
PC	Polycarbonat / polycarbonate / polycarbonate
PM	Polymex / polymex / polymex
PP	Polypropylen / polypropylene / polypropylène
PS	Polystyrol / polystyrene / polystyrène
PVC	Polyvinylchlorid / polyvinylchloride / chlorure de polyvinyle
RH	Roßhaar / horsehair / crin de cheval

## Farbe / colour / couleur

	transparent / transparent / transparent		blau / blue / bleu
	weiß / white / blanc		grün / green / vert
	gelb / yellow / jaune		grau / grey / gris
	rot / red / rouge		schwarz / black / noir
	lila / violet / violet		natur / nature / naturel

## Stielverbindung / handle fixation / fixation de manche

	Stecksystem mit Überwurfmutter: „einstecken – zuschrauben – bombenfest“ coupling system with cap: „stick in – screw down – ready to use“ système fixation avec bague: „mettre – visser – prêt à usage“
	Schraubgewinde / screwing thread / filet de vis
	Konus ohne Gewinde / cone without thread / cône sans filet

°C Hitzebeständigkeit der Borsten gegen Heißluft in °C / heat resistance of bristles against hot air in °C / résistance des fibres à la chaleur contre air chaud en °C



Logo für Professionelle Hygiene-Bürstenwaren PHB gemäß Zulassung durch den Europäischen Bürstenverband F.E.I.B.P. vom 1.1.2002 / logo for Professional Hygiene Brushware PHB as approved from the European Brushware Federation F.E.I.B.P. starting from the 1.1.2002 / logo pour Brosserie d'Hygiène Professionnelle selon directive de la Fédération Européenne de la Brosserie F.E.I.B.P. du 1.1.2002

 neu / new / nouveau



Art.Nr.	Maße / mm	Besatzhöhe / mm	Besatzmaterial	I	Farbe		°C	Gewinde
art.no.	block / mm	bristle trim / mm	bristle	∇	colour		°C	thread
art.no.	corps / mm	taille garniture / mm	matériel	▲	couleur		°C	vissage

**Besen mit Teleskopstiel / brooms with telescopic handle / balais avec manche télescopique**

86922	PP 230 x 35	85	PBT Ø 0,25	I	■		140°C	⊙	
86952	PP 230 x 35	110	PBT Ø 1,0	I	■		140°C	⊙	

**Kehrgarnituren mit langem Stahlstiel / dustpan-sets with long metal handle / pelles et balayettes avec manche long en métal**

1990	PP 240 x 980	60	PM Ø 0,20	I	■		80°C		
19901	PP 240 x 980	60	PM Ø 0,20	I	■		80°C		
19902	PP 240 x 980	60	PM Ø 0,20	I	■		80°C		

**Kehrgarnituren mit langem Alustiel / dustpan-sets with long alu handle / pelles et balayettes avec manche long en alu**

8999	ABS 310 x 840	125	PVC Ø 0,80-1,50	∇	■		60°C		
------	---------------	-----	-----------------	---	---	--	------	--	--

Art.Nr.	Maße / mm	Material	Farbe	°C	Gewinde
art.no.	block / mm	material	colour	°C	thread
art.no.	corps / mm	matériel	couleur	°C	vissage

**Feuchtwischer mit Stahlstiel / sponge-mops with metal handle / ensembles lavage de sol avec manche métallique**

8871	225 x 87 x 1340	Zelluloseschwamm/cellulose sponge/éponge cellulosique	■	120°C	
------	-----------------	---	---	-------	--

**Ersatzschwämme für Feuchtwischer / refill sponges / recharges éponges**

8873	225 x 87 x 43	Zelluloseschwamm/cellulose sponge/éponge cellulosique	■	120°C	
------	---------------	---	---	-------	--



1990

86922

19902

86952

19901

8999

8873

8871



Art.Nr.	Maße / mm	Besatzhöhe / mm	Besatzmaterial		Farbe		°C	
art.no.	block / mm	bristle trim / mm	bristle	↓	colour		°C	
art.no.	corps / mm	taille garniture / mm	matériel	▲	couleur		°C	

### Handwaschbürsten / nail-brushes / brosse à ongles

3150	PS 95 x 47	13/9	Nyl 6.6 Ø 0,35	I	□		130°C	
71200	PS 90 x 30	13	Nyl 6.6 Ø 0,35	I	□		130°C	
720	PS 97 x 47	10/8	PBT Ø 0,35	I	■		140°C	

### Handwaschbürsten mit Köcher / nail-brushes with suspension bracket / brosse à ongles avec support

3250	PS 95 x 55 x 35	13/9	Nyl 6.6 Ø 0,35	I	□		130°C	
730	PS 95 x 55 x 35	10/8	PBT Ø 0,35	I	■		140°C	

### WC-Rundbürsten / toilet-brushes round / brosse à wc rondes

6120	PP 400 x Ø 80	25	PP Ø 0,35	I	□		80°C	
61300	PP 365 x Ø 75	25	PP Ø 0,35	I	□		80°C	

### WC-Randreinigerbürsten / loop-shaped toilet-brushes / brosse à wc avec façon de coulant

6140	PP 400 x Ø 80	25	PP Ø 0,35	I	□		80°C	
61500	PP 365 x Ø 75	25	PP Ø 0,35	I	□		80°C	

### WC-Bürsten mit Flüssigkeitsspender / toilet-brushes with liquid-soap-dispenser / brosse à wc avec dispensateur de savon liquide

616	PP 350 x 90	Ø 50	Nyl 6.0 Ø 0,35	I	□		100°C	
617	PP 400 x 80	Ø 50	Nyl 6.0 Ø 0,35	I	□		100°C	

### Badewannen-, Dusch- und Waschbeckenbürsten / special cleaning brushes for bath-tubes, showers and washing-basins / brosse spéciales pour baignoires et lavabos

618	PP 280 x 130	65	Nyl 6.6 Ø 0,40	I	□		130°C	
-----	--------------	----	----------------	---	---	--	-------	--

Art.Nr.	Maße / mm	Material	Farbe	Bürste
art.no.	block / mm	material	colour	brush
art.no.	corps / mm	matériel	couleur	brosse

### WC-Garnituren / toilet-sets / ensembles wc

6590	Ø 132 x 375	PP Topf/caddy/rond	□	61300
6610	145 x 145 x 375	PP eckig/square/carré	□	61300

61500



6140



6610



6590



617

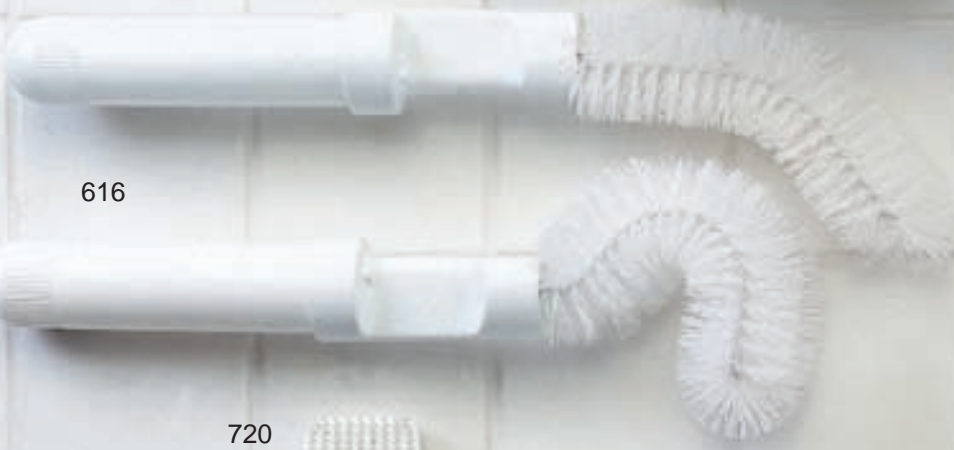

616

61300



6120



720



730



71200



618

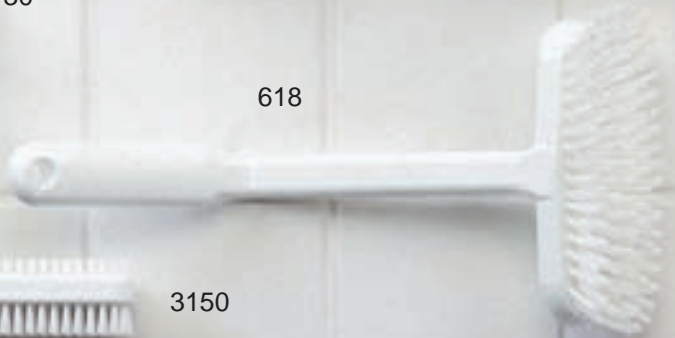

3250



3150





Art.Nr. art.no. art.no.	Maße / mm block / mm corps / mm	Material material matériel	Farbe colour couleur	Bürste brush brosse	
-------------------------------	---------------------------------------	----------------------------------	----------------------------	---------------------------	---

**WC-Garnituren / toilet-sets / ensembles wc**

6550	Ø 140 x 375	PP rund/round/rond	<input type="checkbox"/>	61300	
6640	145 x 145 x 415	PS eckig/square/carré	<input type="checkbox"/>	6140	
668	145 x 145 x 405	PS eckig/square/carré	<input type="checkbox"/>	616	
6700	115 x 100 x 410	PP Wand/wall/mur	<input type="checkbox"/>	61300	
6840	Ø 180 x 410	PS „Zwiebel“	<input type="checkbox"/>	6140	



6700



668



6550



6640



6840



Art.Nr.	Maße / mm	Besatzhöhe / mm	Besatzmaterial		Farbe		°C	
art.no.	block / mm	bristle trim / mm	bristle	∨	colour		°C	
art.no.	corps / mm	taille garniture / mm	matériel	▲	couleur		°C	

**Spülbürsten mit Edelstahl-Griff / dishwashing-brushes with stainless steel handle /  
brosses à vaisselle avec manche en acier inox**

15090	PP 220 x 40	20	PBT Ø 0,35				140°C	
15190	PP 225 x 53	20	PBT Ø 0,35				140°C	
15390	PP 225 x 70	20	PBT Ø 0,35				140°C	

**Ersatzköpfe für Spülbürsten mit Edelstahl-Griff / recharge-heads for dishwashing-brushes with  
stainless steel handle / têtes de rechange pour brosses à vaisselle avec manche en acier inox**

15091	PP 145 x 40	20	PBT Ø 0,35				140°C	
15191	PP 155 x 53	20	PBT Ø 0,35				140°C	
15391	PP 165 x 70	20	PBT Ø 0,35				140°C	

**Kehrgarnituren in Edelstahl / dustpan-sets in stainless steel / pelles et balayettes en acier inox**

5000	390 x 240 x 110	45	PM Ø 0,25				80°C	
------	-----------------	----	-----------	--	--	--	------	--

**Handbesen für Kehrgarnituren in Edelstahl / hand-brushes for dustpan-sets in stainless steel /  
balayettes pour pelles et balayettes en acier inox**

50092	290 x 25	48	PM Ø 0,25				80°C	
-------	----------	----	-----------	--	--	--	------	--







Art.Nr.	Maße / mm	Material	Farbe	°C	Gewinde
art.no.	block / mm	material	colour	°C	thread
art.no.	corps / mm	matériel	couleur	°C	vissage



**micro-soft Bodenwischer mit Teleskopstiel / micro-soft wipers with telescopic handle / micro-soft nettoyeurs de sol avec manche télescopique**

8442	420 x 140 x 1215/2000	Mischgewebe Baumwolle+Polyester/mixed fabric cotton+polyester/ toile métisse coton+polyester		40°C	
8445	420 x 140 x 1215/2000	Polyester		40°C	

**micro-soft Ersatz für Bodenwischer / micro-soft refills for wiper / micro-soft recharges pour nettoyeur de sol**

8441	420 x 140	Mischgewebe Baumwolle+Polyester/mixed fabric cotton+polyester/ toile métisse coton+polyester		40°C	
8491	420 x 140	Polyester		40°C	

**micro-soft Handschuhe / micro-soft gloves / micro-soft gants**

8410	210 x 150	Mischgewebe Baumwolle+Polyester/mixed fabric cotton+polyester/ toile métisse coton+polyester		40°C	
------	-----------	---	--	------	--

**micro-soft Fensterwascher / micro-soft window-washers / micro-soft raclettes-vitres**

8475	210 x 300	Polyester		40°C	
------	-----------	-----------	--	------	--

**micro-soft Staubtücher / micro-soft dusters / micro-soft chiffons à poussière**

8415	400 x 400	Polyester		40°C	
------	-----------	-----------	--	------	--

**micro-soft Ersatz für Fensterwascher / micro-soft refills for window-washers / micro-soft recharges pour raclettes-vitres**

8476	80 x 300	Polyester		40°C	
------	----------	-----------	--	------	--

Art.Nr.	Länge / mm	Außen-Ø / mm	Wandstärke / mm	Material	Farbe Kappe	Gewinde
art.no.	length / mm	Ø ext. / mm	thickness / mm	material	colour hanger	thread
art.no.	longeur / mm	Ø ext. / mm	paroi / mm	matériel	couleur poignée	vissage



**Teleskopstiele / telescopic handles / manches telescopiques**

07198	1160/2000	20/15	0,40	Stahlrohr weiß rilsaniert/metal white epoxy-lacquered/ acier rilsanisé blanc		
-------	-----------	-------	------	---	--	--



8415



8491



8445



8442



8441



8475



07198



8410



8476

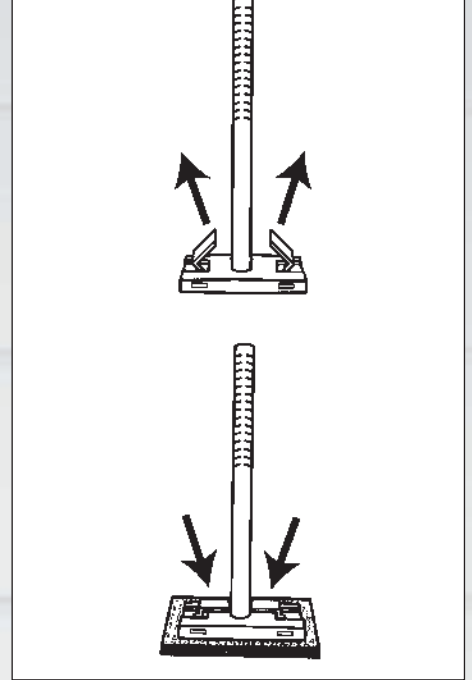

Art.Nr.	Maße / mm	Material	Farbe	°C	Gewinde	
art.no.	block / mm	material	colour	°C	thread	
art.no.	corps / mm	material	couleur	°C	vissage	



**Boden-Padhalter ohne Pads / floor pad holders without pads /  
raclettes multi-fonctions au sol sans tampons à gratter**

8617	230 x 95	PP		80°C		
------	----------	----	---	------	---	---

**Schwämme / sponges / éponges**

8621	150 x 100 x 40	PP abrasiv/abrasive/abrasive		 80°C		
------	----------------	------------------------------	---	--	--	--



**Langstiel-Padhalter mit Pads / hand pad holders with long handle with pads /  
raclettes multi-fonctions avec manche long et avec tampons à gratter**



8610	390 x 120 x 85	PA GF + 2 Pads/2 pads/2 tampons à gratter		 240°C		
------	----------------	---	---	---	--	--



**Hand-Padhalter ohne Pads / hand pad holders without pads /  
raclettes multi-fonctions avec manche sans tampons à gratter**



8616	235 x 95	PP		80°C		
------	----------	----	---	------	--	---

**Ersatz-Scheuervlies-Pads / refill fleece pads / recharges tampons à gratter**

8615	150 x 100	synthetisches Faservlies/synthetic fleece/tampon synthétique für/for/pour art. 8612		 60°C		
------	-----------	--	---	--	--	--

8623	260 x 120	synthetisches Faservlies/synthetic fleece/tampon synthétique für/for/pour art. 8616, 8617		 60°C		
------	-----------	--	---	--	--	--

8624	260 x 120	synthetisches Faservlies/synthetic fleece/tampon synthétique für/for/pour art. 8616, 8617		 60°C		
------	-----------	--	---	--	--	--

8625	260 x 120	synthetisches Faservlies/synthetic fleece/tampon synthétique für/for/pour art. 8616, 8617		 60°C		
------	-----------	--	---	--	--	--

8615



8621



8610



8616



8617



8625



8623



8624



Art.Nr.	Maße / mm	Arbeitsbreite	Material	Farbe	°C	Gewinde
art.no.	block / mm	width	material	colour	°C	thread
art.no.	corps / mm	largeur	matériel	couleur	°C	vissage

#### Fensterwischer / window-wipers / raclettes-vitres

0750	PP 213 x 250	250	Gummilippe/rubber-lip/caoutchouc	■	70°C	⊙
0760	PP 213 x 350	350	Gummilippe/rubber-lip/caoutchouc	■	70°C	⊙
540	PP 155 x 200	200	Gummilippe/rubber-lip/caoutchouc	■	70°C	⊙

#### Fensterreiniger / window-washers / raclettes-vitres

0770	PP 185 x 255	255	Spezialschwamm+Gummilippe/special sponge+rubber-lip/éponge+caoutchouc	■	60°C	⊙
------	--------------	-----	---	---	------	---

#### Tisch- und Verkaufsthekenreiniger / table- and sales-counter-cleaners / racloirs pour tables et comptoirs

8795	PP 190 x 255	255	Zellkautschuk+Gummilippe/special rubber+rubber-lip/caoutchouc cellulaire+caoutchouc	■		⊙
------	--------------	-----	---	---	--	---

#### Winkeladapter / swivel-adapters / adaptateurs d'angle

8716	PA 110 x Ø 37	variable Stielstellung/flexible handle position/position de manche flexible	□	100°C	⊙	⊙
8718	PA 220 x Ø 30	variable Stielstellung/flexible handle position/position de manche flexible	□	100°C	⊙	▽



5000



15191



15091



50092



15391



15090



15190



15390